



NOVO

Building Products



MOULDINGS | SHEET GOODS | BOARDS | EXTERIOR MILLWORK
AMHERST DISTRIBUTION CENTER

our STORY

DEEP ROOTS. HIGH STANDARDS. BRIGHT FUTURE.

Founded in 1946, Novo Building Products (previously known as Empire Moulding & Millwork) has grown into one of the largest millwork distribution and manufacturing

companies in the United States. With a geographic footprint that touches the majority of the eastern half of the United States, Novo Building Products is positioned for continued expansion.

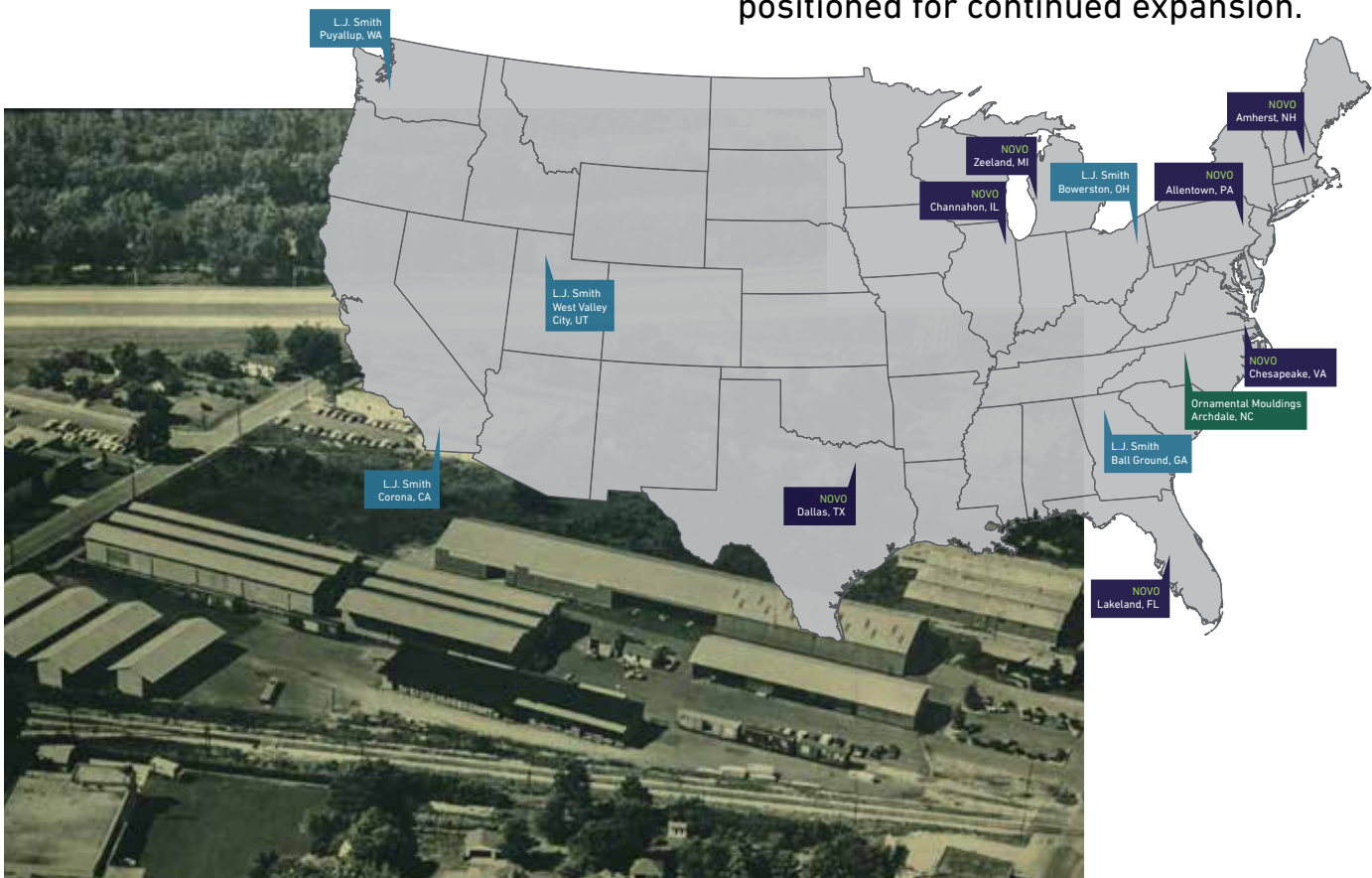

our

FAMILY

NOVO BUILDING PRODUCTS IS PROUD TO BE PART OF THE ADENTRA FAMILY.



Novo Building Products is an industry leading manufacturer and distributor of mouldings, stair parts, doors, and specialty building products. We serve building material dealers (lumberyards), door shops, retail home centers, and millwork manufacturing partners throughout the United States and parts of Canada and Mexico.

Learn more at NOVOBP.COM.

ADENTRA is one of North America's largest distributors of architectural-grade building and millwork products to the residential and commercial construction industries. Adentra currently operates a network of 86 distribution and fabrication facilities in North America consisting of five industry leading distribution brands: Hardwoods Specialty Products, Mid-Am Supply, Frank Paxton Lumber Company, Rugby Architectural Building Products, and Novo Building Products.

Learn more at ADENTRAgroup.com.



Style is individual, personal, and unique.
Make your room a reflection of you...

DISTINGUISH YOUR STYLE



TABLE OF CONTENTS

INSPIRATION	5-11	BASE	26-29
DECORATIVE MOULDING	12-14	CROWN	30-32
BUILDUPS	15	WAINSCOTING SHIPLAP	33
PRO PORTAL SIGN-UP	16	BACK BAND STOPS WALL RAIL	34
CUSTOM MANUFACTURING.....	17	CHAIR RAILS JAMBS	
BOARDS	18	WINDOW & DOOR MISC	35
SHEET GOODS	19-21	GENERAL PURPOSE	36
CASING	22-25	TURNCRAFT COLUMNS	37
BASE CAP	26	MOULDING INDEX	38
		QUALITY PARTS LISTING	39



The mouldings listed may not be as shown in the image but are represented to achieve a similar style or look:

041 Crown | **1x4** Primed Board | **B200** Casing
738 Base | **163** Base Cap

Traditional

Ranch, Classic, Colonial, Early American, Inviting & Timeless...

Traditional Mouldings enhance any home style from Midwestern, Early American to Coastal. They blend perfectly with the classic style furnishing and timeless building materials of today. NOVO has a vast selection of traditional style mouldings to match and enhance your own unique style.



041
Crown

1-3/16 x 6-5/16



1x6 Board



B200 Windsor
Casing

1-1/16 x 3-1/2



738 Base

9/16 x 5-1/4



163
Base Cap

11/16 x 1-3/8

Profiles shown are not to scale.

WARNING: Drilling, sawing, sanding or machining wood products can expose you to wood dust, a substance known to the State of California to cause cancer. Avoid inhaling wood dust or use a dust mask or other safeguards for personal protection. For more information go to www.P65Warnings.ca.gov/wood



The mouldings listed may not be as shown in the image but are represented to achieve a similar style or look:

STCA Casing | Architrave made by: 1x6 S4S & 280 Back Band (x2)
STBA Base | L 254 Shoe

Contemporary

Eclectic, Artistic, Avant-Garde. Full of life, culture, color, texture, unique and found objects, natural and man made materials...

At its core, the word "contemporary" means "of the moment". Sleek & thoughtful, contemporary design spaces often feature a mixture of both straight and elegantly curved lines, which can be seen as a slight nod to this style's art deco roots. Today, the look is defined by curved lines, and embraces minimalistic elements highlighting grays, beiges and shades of white. Although the contemporary trend changes with time, the basic cutting edge simplicity and idealism remains as unique as your vision.

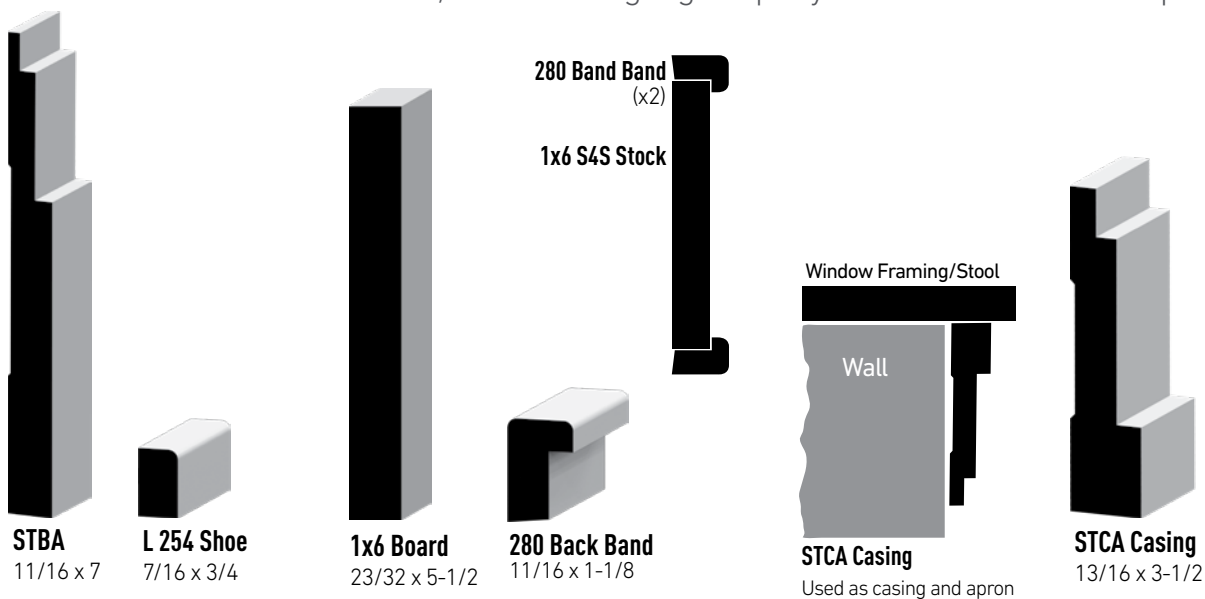

Profiles shown are not to scale.



The mouldings listed may not be as shown in the image but are represented to achieve a similar style or look:

Crown Buildup: **041** Crown / **LANDE** Base
 Shelf Rail/Chair Buildup: **ANDE** Casing / **163** Base Cap
 Base Buildup: **LANDE** Base / **254** Parting / **ANDE** Casing

Victorian

Glamorous, Ornate, Art Deco, Baroque, Southern Plantation, Colonial Estate...

Victorian Mouldings hearken to the richness of old world artisan builders, craftsman and clothiers that regarded every part of their work a piece of art. It is a style that can transform the bland into a bold statement of line and form. Ornate mouldings can be combined to restore a great Painted Lady or add a subtle flair and richness to add glamour to any room in your home.

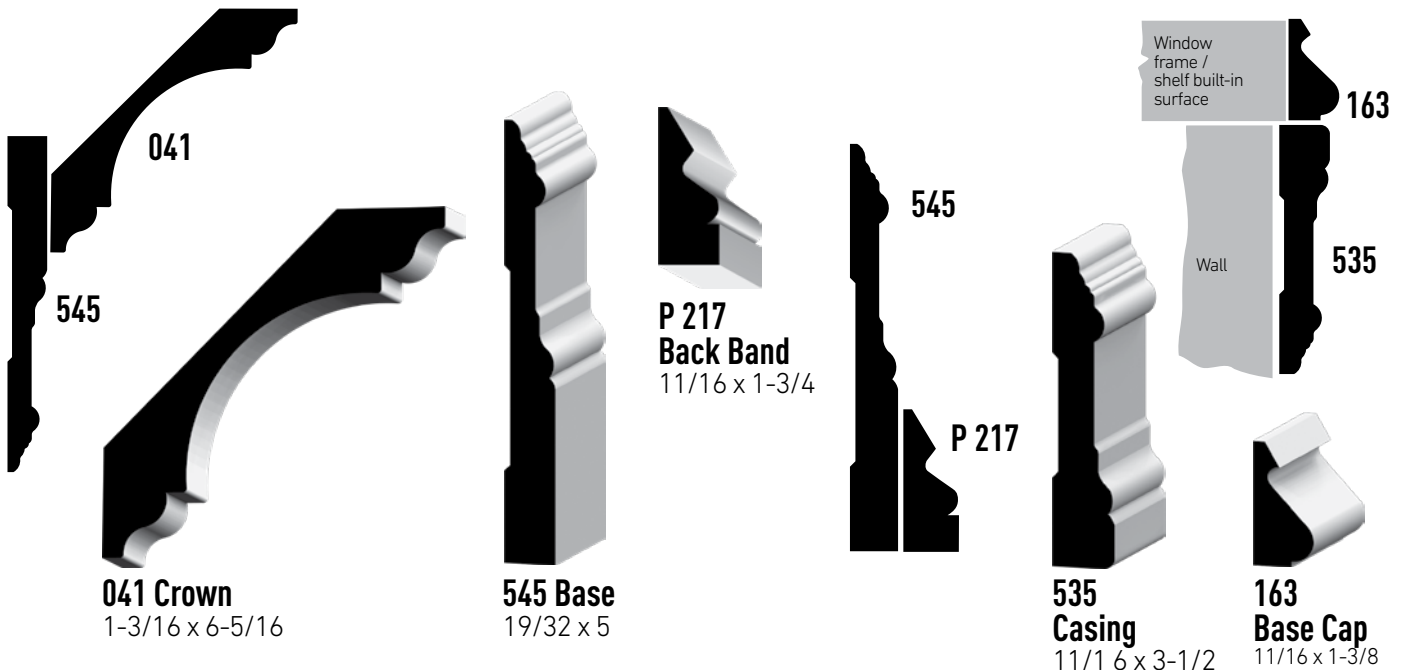

Profiles shown are not to scale.

WARNING: Drilling, sawing, sanding or machining wood products can expose you to wood dust, a substance known to the State of California to cause cancer. Avoid inhaling wood dust or use a dust mask or other safeguards for personal protection. For more information go to www.P65Warnings.ca.gov/wood



The mouldings listed may not be as shown in the image but are represented to achieve a similar style or look:



B G312 Casing w/**280** Back Band Casing | **B G512** Base | **B G100** Shoe
SL16 Shiplap | **1x6** Board | **3 BEAM 8 ORRMP 5x5** Faux Beam

Farmhouse

Farm & cottage, Rustic & Finished, Handcrafted & Milled, Natural & Painted Woods, Sturdy Beams & Headers, Livable Luxury — Frontier Simplicity... work... restore...

Classic, elegant and comfortable, the modern farmhouse decorating is rooted in rustic country charm peppered with warm minimalism. Striking just the right balance of pastoral and refined, modern farmhouse decor emphasizes comfort and casual living with contemporary sensibilities reflective of today's times. NOVO stocks a wide variety of hardwood and primed mouldings, boards, and wall panels from wainscoting, bead-board to shiplap. Combined with faux beams from Ornamental Mouldings to create warm and inviting spaces from cozy to dramatic and inviting for a family gathering.

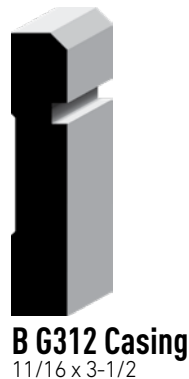
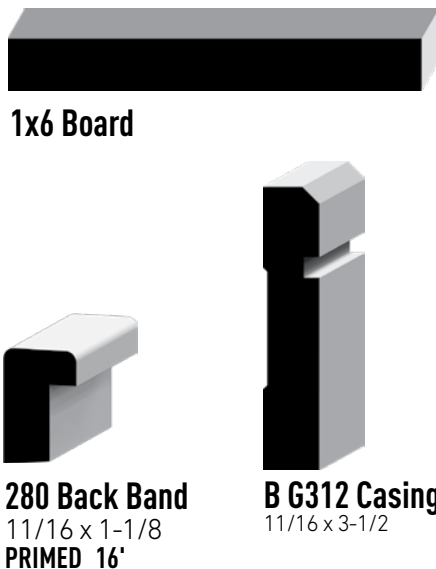

Profiles shown are not to scale.



The mouldings listed may not be as shown in the image but are represented to achieve a similar style or look: **L 432 Casing w/280 Back Band** | **L 414 E1E Base w/280 Back Band** | **126 Shoe**
L 414 E1E Base w/163 Base Cap | **5 BEAM 8 ORRMP 5x5 Faux Beam**

Craftsman

Line & Structure, Handcrafted, Architectural, Artisan Craftsman, Modern-Farmhouse, Western Ranch...

Craftsman homes are full of endless detail and character, known for their natural materials, cozy interiors, and wide porches. Patterns and lines show the Arts & Crafts Architectural style through the use of natural woods combined with simple paint schemes. Wainscoting or beadboard detailing, and decorated ceilings with beams will help to give your home that warm feeling.



L 432 E1E
9/16 x 3-1/2

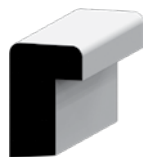

280 Back Band
11/16 x 1-1/8



163 Base Cap
11/16 x 1-3/8



L 414 E1E Base
9/16 x 4-1/4



126 Shoe
1/2 x 3/4



5 BEAM 8 ORRMP
Rustic Maple Beam

Profiles shown are not to scale.

WARNING: Drilling, sawing, sanding or machining wood products can expose you to wood dust, a substance known to the State of California to cause cancer. Avoid inhaling wood dust or use a dust mask or other safeguards for personal protection. For more information go to www.P65Warnings.ca.gov/wood

Craftsman | Sleek, Modern, Simple



STCA Step Casing | STBA Step Base | L254 Craftsman Shoe
Frameport® Shaker 3-panel Craftsman door

Shoe

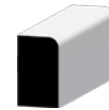

L 254 Shoe
7/16 x 3/4
PRIMED 16'



B G100 Shoe
5/8 x 1
PRIMED 16'

Crown



E519
9/16 x 4-1/4
MDF 16'

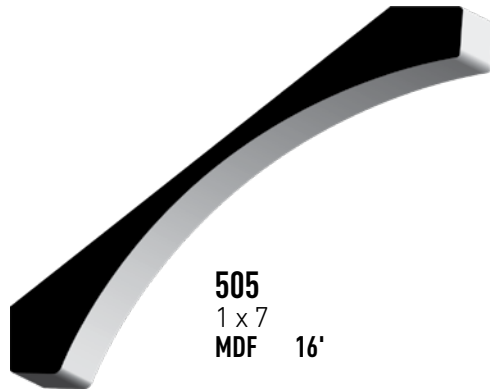

505
1 x 7
MDF 16'

Base



L 414 E1E
9/16 x 4-1/4
PRIMED
16'



W B514
9/16 x 5-1/4
PRIMED 16'



L 514 E1E
9/16 x 5-1/4
PRIMED 16'



512E E1E
1/2 x 5-1/2
MDF 16'



B G512
9/16 x 5-1/2
PRIMED 16'



STBA
11/16 x 7
PRIMED 16'



SCBA
11/16 x 7
PRIMED 16'



B G712
9/16 x 7-1/2
PRIMED 16'

Back Band

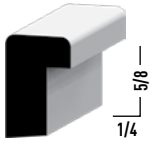

280 Back Band
1 1/16 x 1-1/8
PRIMED 16'



Casing



452 E2E
1 1/16 x 2-1/2
PRIMED 16'



L 452 E1E
1 1/16 x 2-1/2
PRIMED 16' | RL



472 E2E
9/16 x 2-1/2
PRIMED 16'
PINE RL
19/32 x 2-1/2
MDF RL



B G212
1 1/16 x 2-1/2
PRIMED 16'



W C312
1 1/16 x 3-1/2
PRIMED 16'



SCCA
13/16 x 3-1/2
PRIMED 16'



B G312
1 1/16 x 3-1/2
PRIMED 16'



L 432 E1E
9/16 x 3-1/2
PRIMED 16'



STCA
13/16 x 3-1/2
PRIMED 16'



B G312 Bevel Grooved Casing | **B G512** Bevel Grooved Base
L254 Craftsman Shoe | **Frameport®** Shaker 3-panel door



SCCA Scoop Casing | **SCBA** Step Base | **L254** Craftsman Shoe
Frameport® Shaker 5-panel door

Decorative Accessories

ORNAMENTAL

DECORATIVE MILLWORK

A NOVO Building Products Company

Expressing a style comes easier and has greater impact when your choices—from ceiling to floor—are all unified. For nearly 100 years, Ornamental Mouldings has been providing distinctive, high-quality millwork to make entire living spaces more beautiful. Our decorative accessory styles inspired by tradition and shaped by the latest trends complement one another for unmatched selection, all in one place.

Mantels and Floating Shelves

Whenever people enter a room, their eyes instantly take stock of the space. Reward their gaze with our Mantels and Floating Shelves, which marry function with details that convey a discerning sensibility.



Pattern	Product	H	D	L	Species
3 Ft. Mantel	3WM ORRMP	5	7	36	Rustic maple
4 Ft. Mantel	4WM ORRMP	5	7	48	
5 Ft. Mantel	5WM ORRMP	5	7	60	
6 Ft. Mantel	6WM ORRMP	5	7	72	



3 Ft. Mantel with insert	B 3WM 01 ORRMP	5	7	36	Rustic maple with aspen insert
4 Ft. Mantel with insert	B 4WM 01 ORRMP	5	7	48	
5 Ft. Mantel with insert	B 5WM 01 ORRMP	5	7	60	
6 Ft. Mantel with insert	B 6WM 01 ORRMP	5	7	72	



4 Ft. Mantel	CLAS 4 ORWHW	3 3/4	7 3/4	48	WHW
5 Ft. Mantel	CLAS 5 ORWHW	3 3/4	7 3/4	60	WHW
6 Ft. Mantel	CLAS 6 ORWHW	3 3/4	7 3/4	72	WHW



5 Ft. Mantel	CLAS 5 OROAK	3 3/4	7 3/4	60	Oak
6 Ft. Mantel	CLAS 6 OROAK	3 3/4	7 3/4	72	Oak

All measurements are in inches. All items are special order. Please call for details.



Farmhouse | **OML14B, OML24C** | Mantel and Beams

Wood Beams



Practical elements like ceiling beams and wooden stairs are prime places for expressing your style. Our Wood Beams and Decorative Stair Parts give you the tools to achieve drama or convey delicate detailing.

Pattern	Product	H	W	L	Species
Prefinished gray beam	3 BEAM 8 ORPGY	3	5	96	Gray WHW
Prefinished gray beam	5 BEAM 8 ORPGY	5	5	96	Gray WHW
Rustic maple beam	3 BEAM 8 ORRMP	3	5	96	Rustic maple
Rustic maple beam	5 BEAM 8 ORRMP	5	5	96	Rustic maple
3 inch metal beam-band/bracket	3 BRKT 5 METAL	3 ⁹ / ₆₄	1 1/2	6 ⁷ / ₁₆	Metal
5 inch metal beam-band/bracket	5 BRKT 5 METAL	5 ¹⁷ / ₆₄	1 1/2	6 ⁵ / ₁₆	Metal

All measurements are in inches. All items are special order. Please call for details.

WARNING: Drilling, sawing, sanding or machining wood products can expose you to wood dust, a substance known to the State of California to cause cancer. Avoid inhaling wood dust or use a dust mask or other safeguards for personal protection. For more information go to www.P65Warnings.ca.gov/wood



Rustic | BR-0001WM, BEAMGRAY-8WHW5x5, 1248C, 1536, 917PB, 1537

Decorative Boards

Create an impact that is more than meets the eye. Use our Decorative Boards to express your creativity with combinations that even at first glance speak volumes about your personal style.



Pattern	Product	W	T	L	Species
Decorative boards	A 1X2 8 MAPLE	1 1/2	7/16	96	Ambrosia Maple
	12X2 8 ORWOK	1 1/2	7/16	96	White Oak
Decorative boards eased edge two sides	12X2 8 ORPGY	1 1/2	7/16	96	Gray Stain
	12X2 8 ORPBK	1 1/2	7/16	96	Black Stain
Decorative boards	A 1X4 8 MAPLE	3 1/2	7/16	96	Ambrosia Maple
	12X4 8 ORWOK	3 1/2	7/16	96	White Oak
Decorative boards eased edge two sides	12X4 8 ORPGY	3 1/2	7/16	96	Gray Stain
	12X4 8 ORPBK	3 1/2	7/16	96	Black Stain
Decorative boards	A 1X6 8 MAPLE	5 1/2	7/16	96	Ambrosia Maple
	12X6 8 ORWOK	5 1/2	7/16	96	White Oak
Decorative boards eased edge two sides	12X6 8 ORPGY	5 1/2	7/16	96	Gray Stain
	12X6 8 ORPBK	5 1/2	7/16	96	Black Stain

All measurements are in inches. All items are special order. Please call for details.

Build-Ups

Combine moulding patterns to create a unique home style.

- Combine crowns, bases, casing, panel moulds, shoe or quarter rounds and more, to create detail, line and pattern.
- Use boards or square stock to build up depth.
- Combine square and eased edges to create richer detail.
- Use moulding with the same style families for a harmonious feel.
- Create completely unique build-ups to fit your own style.



Build-Up Option

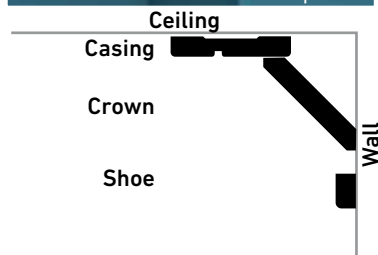

Build-Up Option

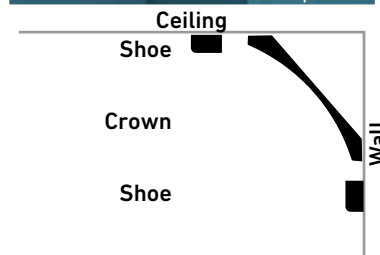

Crown



- Ⓐ Crown
- Ⓑ S4S
- Ⓒ Cove

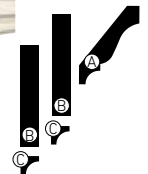

- Ⓐ Crown
- Ⓑ Base

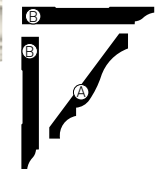

Chair Rail



- Ⓐ Cove
- Ⓑ S4S
- Ⓒ Chair Rail



- Ⓐ Chair Rail Backer
- Ⓑ Chair Rail

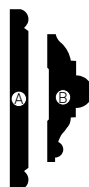

Casing



- Ⓐ Stop
- Ⓑ Casing
- Ⓒ Cove

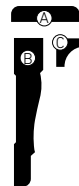

- Ⓐ Cove
- Ⓑ Casing
- Ⓒ Shoe



Base



- Ⓐ Shoe
- Ⓑ S4S
- Ⓒ Base
- Ⓓ Quarter Round

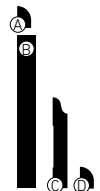

- Ⓐ Cap
- Ⓑ S4S
- Ⓒ Quarter Round

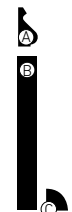



NOVO Building Products is proud to offer a brand new efficient self-service online portal.



Full access to stocked product pricing



Easily place orders on any desktop or mobile device



Receive order status update



Follow the steps below to sign up today!

1. Locate your Customer Code from the "Ship To" line on your order acknowledgment.
2. Navigate to NOVOBP.com. Go to SIGN IN. Select "Create An Account".
3. Fill in all fields marked with "Required" and select "Create Account".
4. Allow 1 business day for account verification, and then explore the new online portal!



Custom Manufacturing on DEMAND by ORNAMENTAL DECORATIVE MILLWORK



Quality custom and short run moulding orders with quick turn around!

Custom Manufacturing
on DEMAND

Specs

- 6-16 ft. lengths (random / clear) - Prime available up to 12 ft.
- Profile max = 11-3/4" width
- Minimum run = 3,000 ft. (less than charge can be applied)
- Unique capabilities: rope, dentil, emboss, carving

Material

- Poplar
- Solid Pine
- Red Oak
- White Oak
- Alder
- Cypress
- Soft Maple
- Hard Maple
- Ambrosia "Rustic" Maple
- Others available upon request and subject to availability

Timing

- 2-3 days for cost quote and estimated lead time
- Moulding sample or CAD drawing required
- Please contact your Sales Representative



Made in the USA

ORNAMENTAL

— DECORATIVE MILLWORK —

A NOVO Building Products Company

Visit NOVOBP.COM
to order NOVO
Building Products
online



Boards



CLEAR PINE - RADIATA BOARDS		
1X4 RPC	3/4 X 3-1/2	16'
1X6 RPC	3/4 X 5-1/2	16'
1X8 RPC	3/4 X 7-1/4	16'
1X10 RPC	3/4 X 9-1/4	16'
1X12 RPC	3/4 X 11-1/4	16'

FJ PRIMED		
1/2 X 4	1/2 X 3-1/2	16'
1/2 X 6	1/2 X 5-1/2	16'
1 X 2	23/32 X 1-1/2	8' 12'
1 X 3	23/32 X 2-1/2	7'2" 16"
1 X 4	23/32 X 3-1/2	7'6" 16'
1 X 5	23/32 X 4-1/2	16'
1 X 6	23/32 X 5-1/2	16'
1 X 8	23/32 X 7-1/4	16'
1 X 10	23/32 X 9-1/4	16'
1 X 12	23/32 X 11-1/4	16'
5/4 X 4	1-1/16 X 3-1/2	16'
5/4 X 5	1-1/16 X 4-1/2	16'
5/4 X 6	1-1/16 X 5-1/2	16'
5/4 X 8	1-1/16 X 7-1/4	16'
5/4 X 10	1-1/16 X 9-1/4	16'
5/4 X 12	1-1/16 X 11-1/4	16'

POPLAR			
Mini Packs Sold in Unit Quantities Listed Only			Approx. Unit Quantity
M 1X4 POPBD	3/4 X 3-1/2	RL	750'
M 1X5 POPBD	3/4 X 4-1/2	RL	625'
M 1X6 POPBD	3/4 X 5-1/2	RL	500'
M 1X8 POPBD	3/4 X 7-1/4	RL	375'
M 1X10 POPBD	3/4 X 9-1/4	RL	300'
M 1X12 POPBD	3/4 X 11-1/4	RL	250'

PRIMED SOLID POPLAR			
Mini Packs Sold in Unit Quantities Listed Only			Approx. Unit Quantity
1X4 POPPM	3/4 X 3-1/2	RL	750'
1X6 POPPM	3/4 X 5-1/2	RL	500'
1X8 POPPM	3/4 X 7-1/4	RL	375'
1X10 POPPM	3/4 X 9-1/4	RL	300'
1X12 POPPM	3/4 X 11-1/4	RL	250'

MDF		
1 X 4	11/16 X 3-1/2	16'
1 X 6	11/16 X 5-1/2	16'
1 X 8	11/16 X 7-1/4	16'
1 X 10	11/16 X 9-1/4	16'
1 X 12	11/16 X 11-1/4	16'



HARDWOOD
PLYWOOD



THERMALLY
FUSED
LAMINATE



MEDIUM
DENSITY
FIBERBOARD



NOVO SHEET GOODS PROGRAM

PREMIUM SHEETS FOR HUNDREDS
OF INTERIOR APPLICATIONS

WIDE SELECTION OF SKU OFFERINGS

DELIVERED ON YOUR NEXT TRUCK ALONG
WITH YOUR MOULDING AND MILLWORK

NOVOBP.COM | 800.253.9000



Sheet Goods

Premium Hardwood - Plywood

NOVO SKU	SPECIE	THICKNESS (IMPERIAL)	THICKNESS (METRIC)	GRADE	SIZE
----------	--------	----------------------	--------------------	-------	------

BIRCH					
144 8 BCPLY	Domestic Natural WPF	1/4"	N/A	A4	48" x 96"
124 8 BCPLY	Domestic Natural WPF	1/2"	N/A	A1	48" x 96"
344 8 BCPLY	Domestic Natural WPF	3/4"	N/A	A1	48" x 96"
M 524 8 BCPLY	Cabinet Grade White	1/4"	5.2mm	C4	48" x 96"
M 124 8 BCPLY	Cabinet Grade White	1/2"	12mm	C2	48" x 96"
M 184 8 BCPLY	Cabinet Grade White	3/4"	18mm	C2	48" x 96"

OAK					
144 8 OKPLY	Domestic WPF	1/4"	N/A	A4	48" x 96"
124 8 OKPLY	Domestic WPF	1/2"	N/A	A1	48" x 96"
344 8 OKPLY	Domestic WPF	3/4"	N/A	A1	48" x 96"

MAPLE					
T 124 8 MPPLY	White UV 2 sides	1/2" UV2S	N/A	Premium	48" x 96"
T 344 8 MPPLY	White UV 2 sides	3/4" UV2S	N/A	Premium	48" x 96"
344 8 MPPLY	White	3/4"	N/A	Premium	48" x 96"

MERANTI (LAUAN)					
M 274 8 MRPLY	MERANTI	1/8"	2.7mm	OVL/BTR	48" x 96"
M 524 8 MRPLY	MERANTI	1/4"	5.2mm	OVL/BTR	48" x 96"

PINE					
144 8 PNPLY	PINE	1/4"	6.5mm	AC	48" x 96"
384 8 PNPLY	PINE	3/8"	9mm	AC	48" x 96"
124 8 PNPLY	PINE	1/2"	12mm	AC	48" x 96"
584 8 PNPLY	PINE	5/8"	15mm	AC	48" x 96"
344 8 PNPLY	PINE	3/4"	18mm	AC	48" x 96"
784 8 PNPLY	PINE	1"	25mm	AC	48" x 96"

🌿 ALL NOVO HARDWOOD PLYWOOD SHEETS MEET OR EXCEED HPVA SPECIFICATIONS



Sheet Goods Sheets & Shelving

NOVO SKU	SPECIE	THICKNESS (IMPERIAL)	THICKNESS (METRIC)	GRADE	SIZE
TFL (THERMALLY FUSED LAMINATE)					
344 8 TFPLY	GOOD 2 SIDE	3/4"	N/A	N/A	49" x 97"
3412 8 TFPLY	EDGE BANDED 1 SIDE	3/4"	N/A	N/A	12" (11-3/4") x 96"
3416 8 TFPLY	EDGE BANDED 1 SIDE	3/4"	N/A	N/A	16" (15-3/4") x 96"
3424 8 TFPLY	EDGE BANDED 1 SIDE	3/4"	N/A	N/A	24" (23-1/4") x 96"



Sheet Goods Medium Density Fiberboard

NOVO SKU	SPECIE	THICKNESS (IMPERIAL)	THICKNESS (METRIC)	GRADE	SIZE
FIBERBOARD					
M 554 8 MDPLY	Ultra-Lite MDF	1/4"	5.5mm	N/A	48" x 96"
M 94 8 MDPLY	Ultra-Lite MDF	3/8"	9mm	N/A	48" x 96"
M 124 8 MDPLY	Ultra-Lite MDF	1/2"	12mm	N/A	48" x 96"
M 154 8 MDPLY	Ultra-Lite MDF	5/8"	15mm	N/A	48" x 96"
M 184 8 MDPLY	Ultra-Lite MDF	3/4"	18mm	N/A	48" x 96"
M 254 8 MDPLY	Ultra-Lite MDF	1"	25mm	N/A	48" x 96"

🌿 ALL NOVO TFL AND MDF SHEETS ARE TSCA IV COMPLIANT and CARB APPROVED

⚠️WARNING: Drilling, sawing, sanding or machining wood products can expose you to wood dust, a substance known to the State of California to cause cancer. Avoid inhaling wood dust or use a dust mask or other safeguards for personal protection. For more information go to www.P65Warnings.ca.gov/wood

Casing



356
 11/16 x 2-1/4
 PRIMED 7' | 14'
 PINE RL
 19/32 x 2-1/4
 MDF 7' | 14'



351
 11/16 x 2-1/2
 PRIMED 7'2" | 14' | 16'
 PINE RL



366
 11/16 x 2-1/4
 PRIMED 7' | 14'



361
 11/16 x 2-1/2
 PRIMED 7' 14'
 PINE RL



327
 11/16 x 2-1/4
 PRIMED 7' | 14'



315
 11/16 x 2-1/2
 PRIMED 16'
 PINE RL



B300 Baby Windsor
 11/16 x 2-1/2
 PRIMED 16'



472 E2E
 9/16 x 2-1/2
 PRIMED 7'2" | 16'
 PINE RL
 19/32 x 2-1/2
 MDF 16'



452 E2E
 11/16 x 2-1/2
 PRIMED 16'



L 452 E1E
 11/16 x 2-1/2
 PRIMED 16'



B G212
 11/16 x 2-1/2
 PRIMED 16'



445A
11/16 x 3-1/4
MDF 16'



682
1 x 3-1/4
MDF 16'



W C312
11/16 x 3-1/2
PRIMED 16'

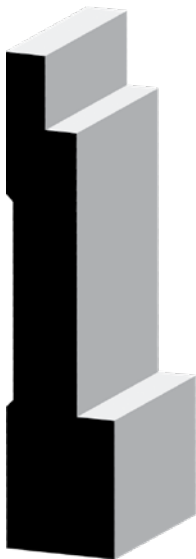

STCA
13/16 x 3-1/2
PRIMED 16'



SCCA
13/16 x 3-1/2
PRIMED 16'



B G312
11/16 x 3-1/2
PRIMED 16'



9750
11/16 x 3-1/2
PRIMED 16'

Casing



432 E2E
9/16 x 3-1/2
PRIMED 16'



L 432 E1E
9/16 x 3-1/2
PRIMED 16'



E 412 E2E
11/16 x 3-1/2
PRIMED 16'



L 361
11/16 x 3-1/2
PRIMED 16'



444
11/16 x 3-1/2
PRIMED 7'3" | 15' | 16'
PINE RL



444A
(18mm) 11/16 X 3-1/2
MDF 16'



535
1 1/16 x 3-1/2
MDF 16'



B225 Stafford
1 1/16 x 3-1/2
PRIMED 7'2" | 15' | 16'



B100
1 1/16 x 4-1/4
PRIMED 16'



RB3
1 x 3-1/2
MDF 16'



B200 Windsor
1-1/16 x 3-1/2
PRIMED 7'2" | 16'

Base Caps | Base



163
Base Cap
 11/16 x 1-3/8
 PRIMED 16'
 PINE 12' | 16'



164
Base Cap
 11/16 x 1-1/8
 PRIMED 16'
 PINE 16'



623
 9/16 x 3-1/4
 PRIMED 16'
 PINE RL
 1/2 x 3-1/4
 MDF 16'



622
 9/16 x 3-1/2
 PRIMED 16'

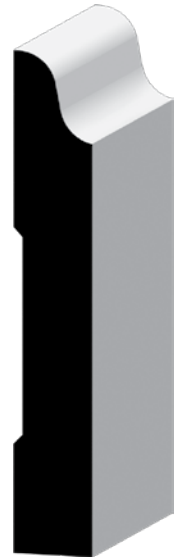

662
 9/16 x 3-1/2
 PRIMED 16'
 PINE RL



712
 9/16 x 3-1/2
 PINE RL
 PRIMED 16'



L 414 E1E
 9/16 x 4-1/4
 PRIMED 16'



750
 9/16 x 4-1/4
 PRIMED 16'



414E E1E
 1/2 x 4-1/4
 MDF 16'



620
9/16 x 4-1/4
PRIMED 16'
1/2 x 4-1/4
MDF 16'



660
9/16 x 4-1/4
PRIMED 16'



4738
9/16 x 4-1/4
PRIMED 16'



L 618
1/2 x 5-1/4
MDF 16'



738
9/16 x 5-1/4
PRIMED 16'



163E
19/32 x 5-1/4
MDF 16'

Base



545
19/32 x 5
MDF 16'



750W
9/16 x 5-1/4
PRIMED 16'



WB514
9/16 x 5-1/4
PRIMED 16'



L 514 E1E
9/16 x 5-1/4
PRIMED 16'



B G512
9/16 x 5-1/2
PRIMED 16'



512E E1E
1/2 x 5-1/2
MDF 16'



SCBA
11/16 x 7
PRIMED 16'



7738
9/16 x 7-1/4
PRIMED 16'



B6712
9/16 x 7-1/2
PRIMED 16'



STBA
11/16 x 7
PRIMED 16'



7163
19/32 x 7-1/4
MDF 16'

Crown

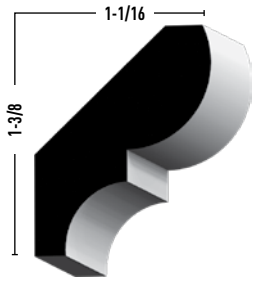

74
 $9/16 \times 1-3/4$
PINE RL
PRIMED 16'

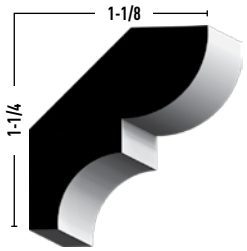

75
 $9/16 \times 1-5/8$
PRIMED 16'
PINE 16' | RL

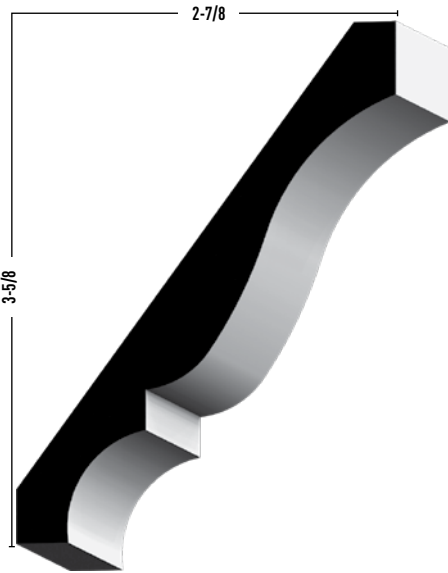

L 47
 $19/32 \times 4-5/8$
MDF 16'
 $9/16 \times 4-5/8$
PRIMED 16'
PINE 16'

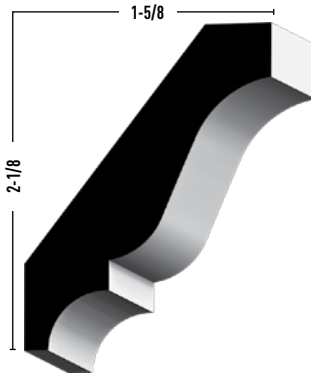

53
 $9/16 \times 2-5/8$
PRIMED 16'
PINE 16'

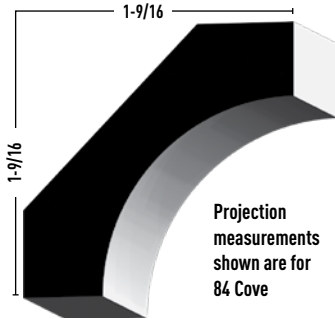

84 Cove
 $9/16 \times 2-1/4$
PINE RL

Projection
 measurements
 shown are for
 84 Cove

85
 $9/16 \times 1-3/4$
PINE RL

86
 $9/16 \times 1-5/8$
PINE RL

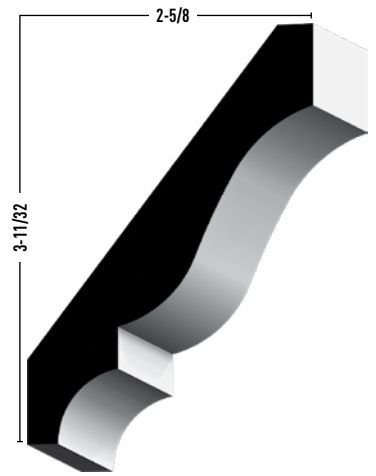

L 49
 $19/32 \times 3-5/8$
MDF 16'
 $9/16 \times 3-5/8$
PRIMED 16'
PINE RL

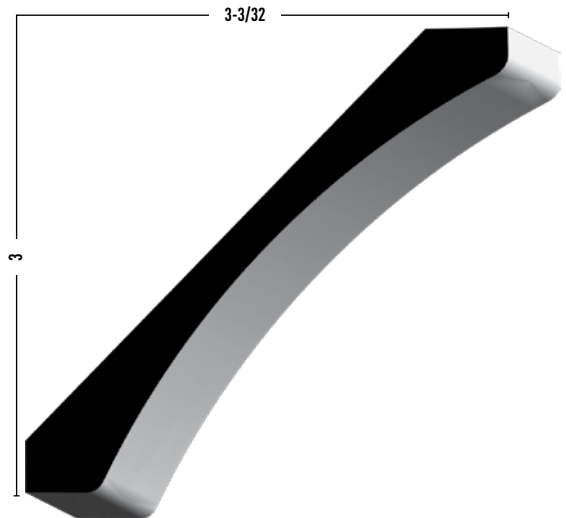

E519
 $9/16 \times 4-1/4$
MDF 16'

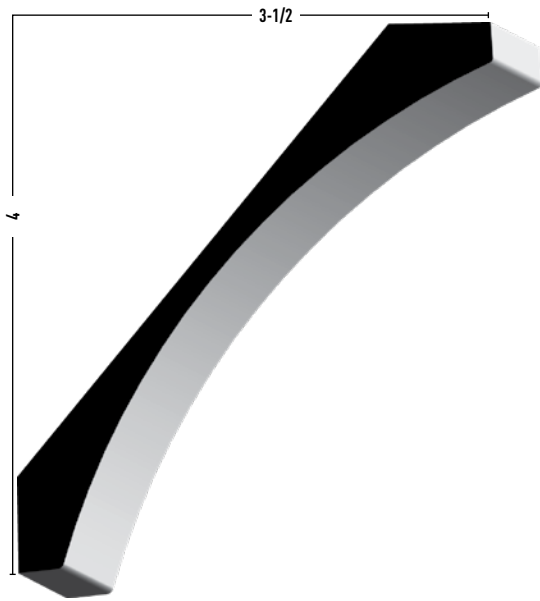

CR291
 3/4 x 5-1/4
 MDF 16'

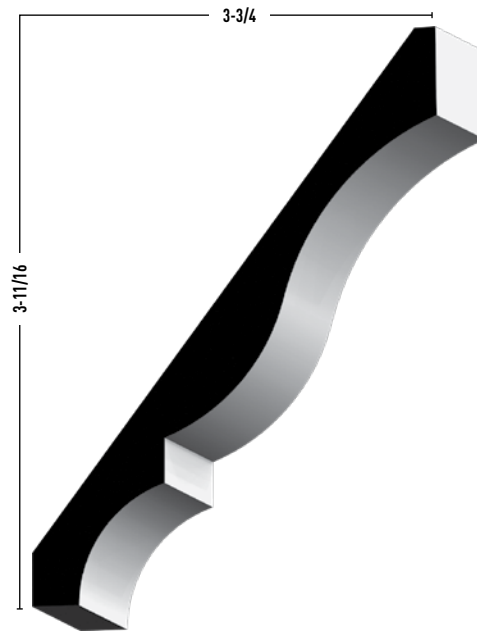

L 46
 9/16 x 5-1/4
 PRIMED 16'

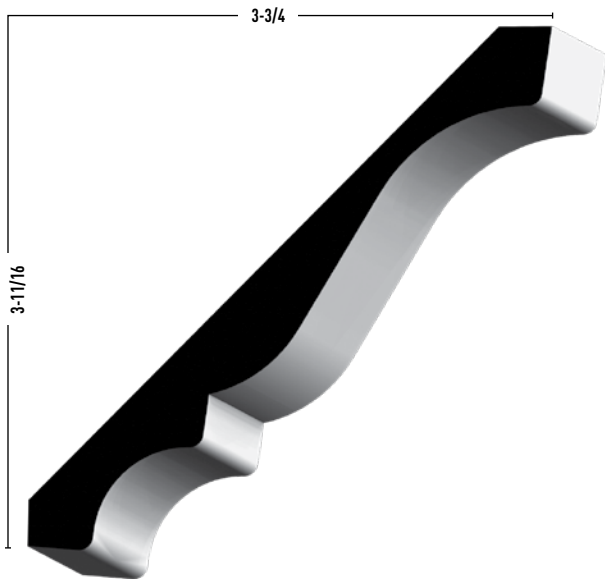

L 45
 (15mm) 19/32 x 5-1/4
 MDF 16'

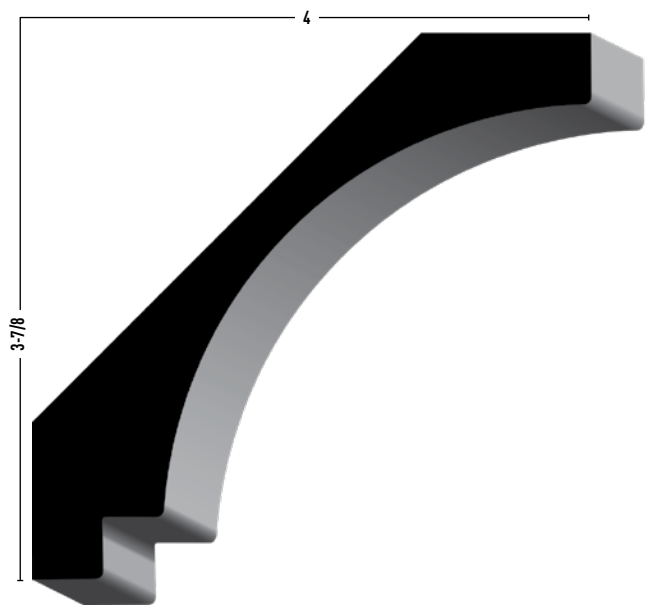

530
 1-3/16 x 5-1/2
 MDF 16'

Crown

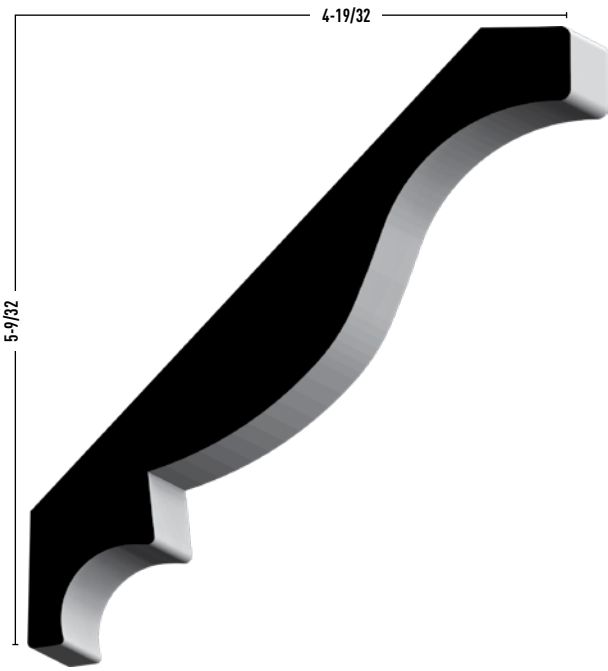

043
1 x 6-15/16
MDF 16'

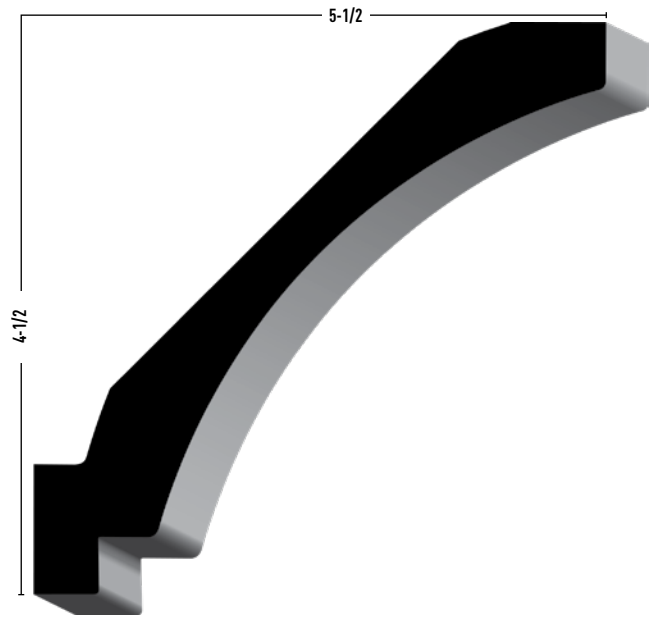

730
1-3/16 x 7
MDF 16'

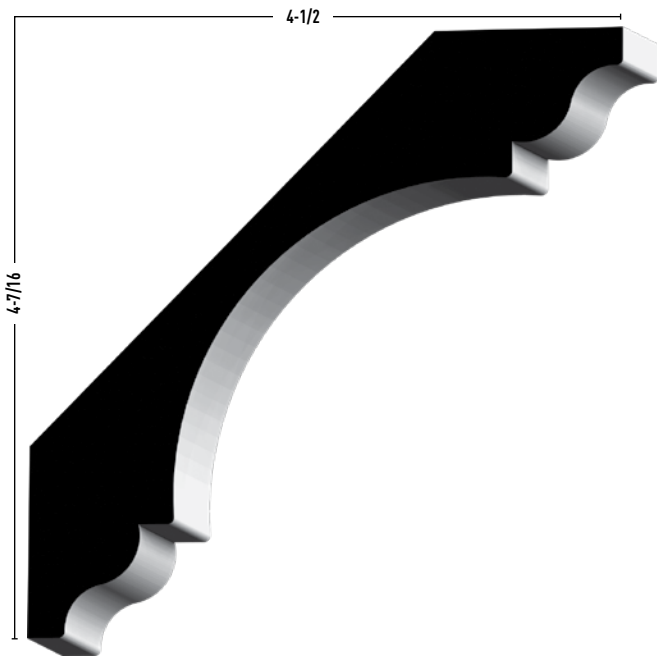

041
1-3/16 x 6-5/16
MDF 16'

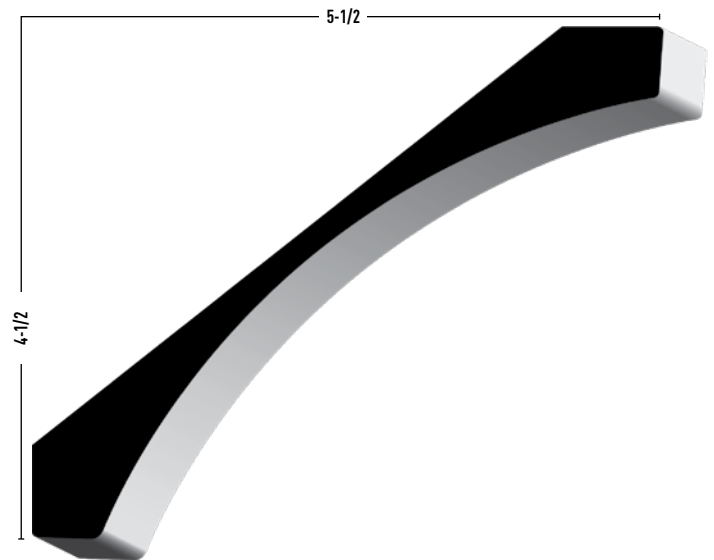

505
1 x 7
MDF 16'

Wainscoting | Shiplap



L CAP EC
 1-3/8 x 1-3/4
PRIMED 16'
 Use with ECB product



**1X6 EC
 Wainscoting**
 23/32 x 5-1/2
PRIMED 16'
 Reversible



**SL16
 Tongue & Groove
 Shiplap**
 11/16 x 5-1/4
MDF 16'



**SL16
 Nickel Gap
 Shiplap**
 5/8 x 5-1/2
PRIMED 16'

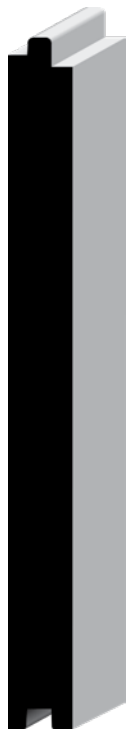

**SL18
 Tongue & Groove
 Shiplap**
 11/16 x 7-1/4
MDF 16'



**SL18
 Nickel Gap
 Shiplap**
 5/8 x 7-1/2
PRIMED 16'



Back Band

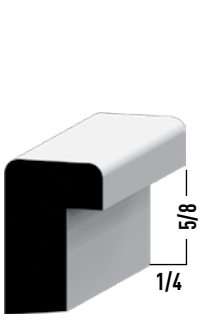

280 Back Band
11/16 x 1-1/8
PRIMED 16'



P 217 Back Band
11/16 x 1-3/4
PRIMED 16'

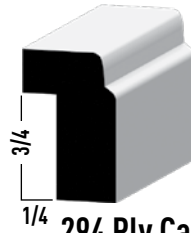

294 Ply Cap
21/32 x 1-3/32
PINE RL

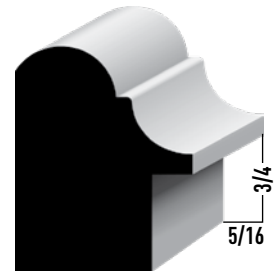

L CAP EC
1-3/8 x 1-3/4
PRIMED 16'

Stops



947 Colonial Stop
3/8 x 1-1/4
PINE 7' | RL
PRIMED 7'



936 Colonial Stop
7/16 x 1-3/8
PRIMED 7



946 Colonial Stop
3/8 x 1-3/8
PINE RL



876 E1E Craftsman Stop
7/16 x 1-3/8
PRIMED 16'



886 E1E Craftsman Stop
3/8 x 1-3/8
PRIMED 7' | 8'4"

Wall Rail

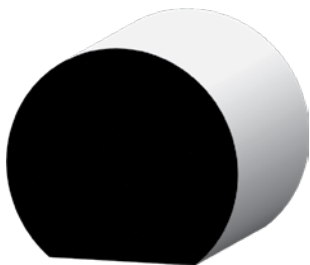

231 Wall Rail
1-1/2 x 1-11/16
SPINE 16'

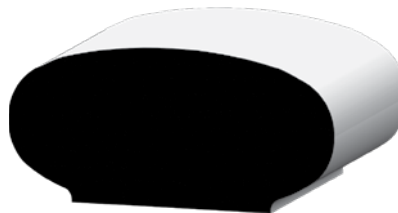

240 Wall Rail
1-1/4 x 2-1/4
SPINE 16'

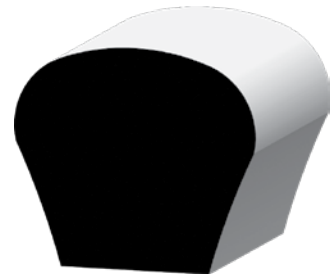

230 Wall Rail
1-1/2 x 1-11/16
SPINE 16'

Chair Rails



300 Chair Rail
1-1/16 x 3
PRIMED 16'



390 Chair Rail
11/16 x 2-5/8
PRIMED 16'
PINE RL

Window & Door Misc.



254 Parting Bead
1/2 x 3/4
PRIMED 16'
PINE 16'



133 Flat Astragal
11/16 x 1-3/4
PRIMED 16'

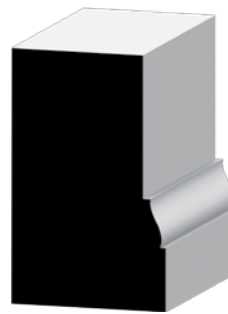

180 Brick Mould
1-1/4 x 2
PRIMED 17'



5 Stool
23/32 x 5-1/2
PRIMED RL

7 Stool
23/32 x 7-1/4
PRIMED RL

Jambs

NOVO SKU	LENGTH	SPECIE	DESCRIPTION
4916 68 FJPMD	6'8"	Finger Joint Primed Pine	11/16 X 4-9/16 JAMB PAIR 81BD
458 68 FJPMD	6'8"	Finger Joint Primed Pine	11/16 X 4-5/8 JAMB PAIR 81BD
478 68 FJPMD	6'8"	Finger Joint Primed Pine	11/16 X 4-7/8 FLAT JAMB PAIR 81BD
678 68 FJPMD	6'8"	Finger Joint Primed Pine	11/16 X 6-7/8 FLAT JAMB PAIR 81BD
6916 68 FJPMD	6'8"	Finger Joint Primed Pine	11/16 X 6-9/16 JAMB PAIR 81BD
6916 80 FJPMD	8'	Finger Joint Primed Pine	11/16 X 6-9/16 JAMB PAIR 97BD
X4916 68 PINEL	6'8"	Pine Veneer w/FJ Core	11/16 X 4-9/16 JAMB SIDE 81BD
X6916 68 PINEV	6'8"	Pine Veneer w/FJ Core	11/16 X 6-9/16 JAMB SIDE 81BD

General Purpose

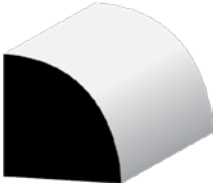

103 Quarter Round
1-1/16 x 1-1/16
PINE RL

105
3/4 x 3/4
PINE RL

106
11/16 x 11/16
PRIMED 16'
PINE RL

108
1/2 x 1/2
PINE 16'

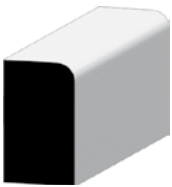

L 254 Craftsman Shoe
7/16 x 3/4
PRIMED 16'



B G100 Shoe
5/8 x 1
PRIMED 16'

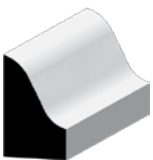

131 Ogee Shoe
1/2 x 3/4
PRIMED 16'



126 Shoe
1/2 x 3/4
PRIMED 16'
PINE 12' | 16'

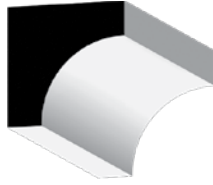

96 Cove
5/8 x 3/4
PINE 16'
OAK RL

93 Cove
3/4 x 3/4
PINE RL

100 Cove
11/16 x 11/16
PRIMED 16'
PINE 16'



94 COVE MOULD
21/32 x 1-3/32
PINE RL

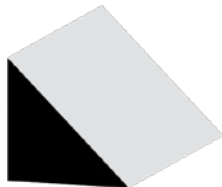

995 Chamfer
3/4 x 3/4
PINE RL



5 263 Lattice
1/4 x 5-1/4
PINE RL

L 265
1/4 x 1-3/4
PINE RL

L 267
1/4 x 1-3/8
PINE 8' | 16' | RL

L 268
1/4 x 1-1/8
PINE RL



142 Screen Mould
1/4 x 3/4
PINE RL

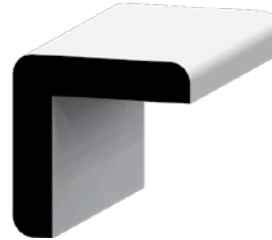

204 Corner Guard
1-5/16 x 1-5/16
PINE 8' | RL

205
1-1/8 x 1-1/8
PINE RL

206
3/4 x 3/4
PINE RL



L 210 Shingle Mould
5/8 x 1-5/8
PRIMED 16'

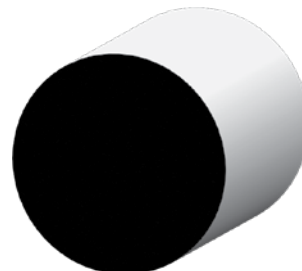

L 233 Closet Pole
1-1/4 Full Round
DFIR RL

Columns and Porch Post



If your project requires decorative support Columns or Porch Posts call us for information. Or check out the styles and products available at:

TURNCRAFT.COM



Moulding Index

Pattern	Pg #
41	32
43	32
L 45	31
L 46	31
L 47	30
L 49	30
53	30
74	30
75	30
84	30
85	30
86	30
93	36
94	36
96	36
B G100	10, 36
B100	25
100	36
103	36
105	36
106	36
108	36
126	36
131	36
133	35
142	36
163	26
163E	27
164	26
180	35
B200	25
204	36
205	36
206	36
L 210	36
B G212	11, 22

Pattern	Pg #
P 217	34
B225	25
230	34
231	34
L 233	36
240	34
254	35, 36
L 254	10, 36
5 263	36
L 265	36
L 267	36
L 268	36
280	11, 34
CR291	31
294	34
B300	22
300	35
B G312	11, 23
W C312	11, 23
315	22
327	22
351	22
356	22
L 361	24
361	22
366	22
390	35
E 412	24
L 414	10, 26
414E	26
L 432	11, 24
432	24
444A	24
444	24
445A	23
452	11, 22

Pattern	Pg #
L 452	11, 22
472	11, 22
505	10, 32
B G512	10, 28
512E	10, 28
L 514	10, 28
WB514	10, 28
E 519	10, 30
530	31
535	25
545	28
L 618	27
620	27
622	26
623	26
660	27
662	26
682	23
B G712	10, 29
712	26
730	32
738	27
4 738	27
7 738	29
750	26
750W	28
876	34
886	34
936	34
946	34
947	34
995	36
7163	29
9750	23
1X6 EC	33
5 STOOL	35

Pattern	Pg #
7 STOOL	35
L CAP EC	33, 34
RB3	25
SCBA	10, 29
SCCA	11, 23
SL16	33
SL18	33
STBA	10, 29
STCA	11, 23

See Page 12-14 for
**Decorative
Accessories**

See Page 15 for
BuildUps

See Page 18 for
Boards

See Pages 19-21 for
Sheet Goods

See Page 35 for
Jambs

See Page 37 for
Columns

Quality Products



Mouldings

- Softwood Mouldings
- Hardwood Mouldings
- Blocks
- Flexible Mouldings

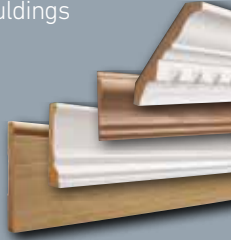

Boards

- Softwood Boards
- Hardwood Boards
- S4S & Eased Edged
- Unfinished, Primed

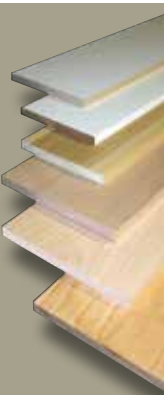

Stair Parts

- Wood & Iron Balusters & Newels
- Post to Post Components
- Over the Post Components
- Stock, Special Order, Custom

Cable Systems/Panel Systems

- Marine Grade 316 Stainless Steel
- Swageless Cable Fittings
- Newels Presized & Predrilled
- Preassembled Panels
- Options for Open Tread, Kneewall & Level Run
- Five rake and 7 level panel widths



A NOVO Building Products Company



NOVO SHEET GOODS PROGRAM

- Premium Sheets For Hundreds Of Interior Applications
- Wide Selection of SKU Offerings
- Delivered On Your Next Truck Along With Your Moulding And Millwork



Columns

- Architectural Wood
- Wood Colonial
- Poly-Classic
- Poly-Classic DuraGlass Square
- Poly-Classic Craftsman
- Poly-Classic Porch Posts
- Wood Porch Posts



Decorative Millwork

- Decorative Wood Mouldings
- Mantels, Wood Beams
- Decorative Risers
- Stained Boards

ORNAMENTAL

— DECORATIVE MILLWORK —

A NOVO Building Products Company





Explore our comprehensive collections of mouldings, stair parts, boards, and exterior millwork as well as find inspiration for every room in the home.



Amherst Distribution Center

1 Bon Terrain Dr.
Amherst, NH 03031

P: 800.253.9000 | F: 800.748.7670

© 2023 NOVOBP, Amherst (Rev. 12/23)

NOVO reserves the right to make changes to the products listed in this catalog without notice and without responsibility for existing units. Drawings may not be to exact scale.

For more information
scan to visit
NOVOBP.COM

